

ABOUT HPOWER

hpower actuators combine fastest response times in μs , superior kHz dynamics, high force generation in the range of tens of kN and nanometer precision in a way that is unmatched by any other linear driving system. The actuation can be obtained without any mechanical wear, making the actuators extremely durable. hpower products include ring and stack type actuators, as well as shakers and shock generators. hpower is the result of the collaboration between piezosystem jena and Piezomechanik GmbH and therefore combines centuries of piezo expertise with new innovations.

STACK TYPE ACTUATORS SERIES PSt 1000/25 VS35

SERIES PST WITH CASING AND PRELOAD,
DIAMETER 35 MM



Concept

Solid Stack type actuators with casing and preload are based on a special smart material known as PZT ceramics. This enables these actuators to achieving outstanding performance with a motion range from $0\ \mu\text{m}$ to $150\ \mu\text{m}$ or even higher on request, while generating maximum forces of up to 25kN. The actuators are available in different lengths, a stack with a length of 50 mm usually possesses a maximum motion of $50\ \mu\text{m}$ to $70\ \mu\text{m}$ (0.1% - 0.15% of the length)

Product highlights

- max. load: 35000 N
- max. force generation: 25000 N
- high stiffness
- high resonant frequency

Options

- low temperature modification
- ultra high vacuum (UHV) modification
- strain gage (SG) measurement system
- piezo material HP (high power & capacitance)

Applications:

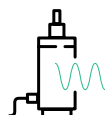

MODAL
ANALYSIS



VIBRATION
CONTROL

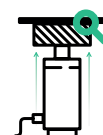

MATERIAL
TESTING

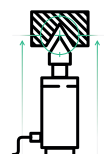

MECHANICAL
ENGINEERING

Technical data of PSt 1000/25 VS35 series

type	motion, μm	voltage range, V	Length, mm	resonant frequency, kHz	Blocking force, N	Maximum load, N	Capacity, nF	Stiffness, N/ μm
PSt 1000/25/7 VS35	7	0...+1000	33	40	25000	35000	140	1800
PSt 1000/25/20 VS35	20	0...+1000	42	35	25000	35000	350	900
PSt 1000/25/40 VS35	40	0...+1000	60	30	25000	35000	800	450
PSt 1000/25/60 VS35	60	0...+1000	78	27	25000	35000	1250	300
PSt 1000/25/80 VS35	80	0...+1000	96	23	25000	35000	1700	250
PSt 1000/25/100 VS35	100	0...+1000	114	20	25000	35000	2150	180
PSt 1000/25/150 VS35	150	0...+1000	154	7	25000	35000	3200	120

Technical drawing of PSt 1000/25 VS35 series

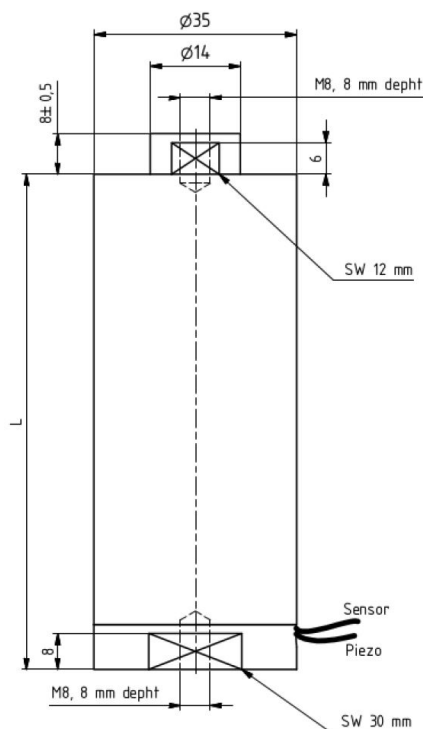

Get in touch with us
and we will help configuring
the best solution.

phone: +1 508-381-0425 (USA) +49 3641 6688-38 (GERMANY)

fax: +1 508-634-6868 (USA) +49 3641 6688-66 (GERMANY)

e-mail: givememore@hpowermotion.com